























































**LEGEND**

-  ELECTRICAL SERVICES SWITCHBOARD.
-  SWITCHBOARD / CONTROL PANEL NOT PROVIDED AS PART OF THE ELECTRICAL SUBCONTRACT.
-  SINGLE POWER OUTLET.
-  DOUBLE POWER OUTLET.
-  DRINK FOUNTAIN POWER OUTLET MOUNTED WITHIN HOUSING.
-  SPECIAL PURPOSE POWER OUTLET.
-  CABLE ACCESS, TYPE AS NOTED.
-  SINGLE PHASE ISOLATOR.
-  THREE PHASE ISOLATOR.
-  CONDUIT ROUTE.
-  x DENOTES CONDUIT TYPE.
-  ELECTRICAL PIT, TYPE AS NOTED.
-  HAND DRYER CONNECTION.
-  LIGHTING PRESENCE DETECTOR SWITCH.
-  ONE-WAY LIGHT SWITCH.
-  TWO-WAY LIGHT SWITCH.
-  CIRCUIT LINE.
-  SWITCH LINE.
-  DB-x - Py POWER CIRCUIT DESIGNATION. DENOTES DB AND CIRCUIT.
-  ELECTRICAL EQUIPMENT AS NOTED.
-  RK OUTLET MOUNTED WITHIN RECESS KIT.
-  RJ45 COMMUNICATIONS OUTLET.
-  PRIVATE METER.
-  MFM MULTI FUNCTION METER
-  FUSE.
-  SINGLE PHASE.
-  THREE PHASE.
-  CURRENT TRANSFORMER C/W REMOVABLE LINK.
-  FUSE LINK.
-  COMBINED FUSE SWITCH.
-  CIRCUIT BREAKER.
-  ISOLATOR.
-  RESIDUAL CURRENT DEVICE.
-  NO CONTACTOR - NORMALLY OPEN.
-  NC CONTACTOR - NORMALLY CLOSED.

**LEGEND**

-  REFER TO DETAIL NOTED FOR THE AREA SHOWN HATCHED. ADDITIONAL OUTLETS & FITTINGS MAY BE SHOWN ON DETAIL.
-  E1: RECESSED GENERAL LED EMERGENCY LIGHT.
-  EX: EMERGENCY LED EXIT LIGHT.
-  Lx: LIGHT FITTING C/W NON-MAINTAINED EMERGENCY BATTERY PACK. TYPE AS NOTED.
-  L1: 40W 600 x 600 SURFACE LED FLAT PANEL.
-  L2: 2400 LONG SUSPENDED 50 x 50 LED EXTRUSION.
-  L3: RECESSED AMENITY DOWNLIGHT.
-  L4: RECESSED CORRIDOR DOWNLIGHT.
-  L5: RECESSED EXTERNAL DOWNLIGHT.
-  L6: 1200 LONG SUSPENDED 50 x 50 LED EXTRUSION.
-  L7: 800 LONG SUSPENDED 50 x 50 LED EXTRUSION.
-  L8: 600 LONG BATTEN C/W INTEGRAL SENSOR.
-  L9: CARPARK FLOOD LIGHT MOUNTED ON A 9m POLE.
-  L10: HIGH LEVEL FLOOD LIGHT.
-  L11: MID LEVEL FLOOD LIGHT.
-  L12: 3200 LONG SUSPENDED 50 x 50 LED EXTRUSION.
-  L13: 1800 LONG SUSPENDED 50 x 50 LED EXTRUSION.
-  L14: 2700 LONG SUSPENDED 50 x 50 LED EXTRUSION.
-  L15: 4300 LONG SUSPENDED 50 x 50 LED EXTRUSION.

**NOTE**  
ALL ELECTRICAL PENETRATIONS THROUGH THE ROOF SHEETING ARE TO BE IN LINE WITH THE STRUCTURAL OR MECHANICAL SERVICES PENETRATIONS TO AVOID DEDICATED FLASHINGS FOR THE ELECTRICAL SERVICES.

**EQUIPMENT:**

- TEST - TEST PUSH BUTTON MOUNTED ON THE DISTRIBUTION BOARD ESCUTCHEON.
- RESET - RESET PUSH BUTTON MOUNTED ON THE DISTRIBUTION BOARD ESCUTCHEON.
- LAMP - AMBER TEST INDICATING LAMP MOUNTED ON THE DISTRIBUTION BOARD ESCUTCHEON.
- Ta - ADJUSTABLE 0-3 HOUR TIMED RELAY.
- Tb - 15 MINUTE RUN-ON TIMER TO OPERATE UPON THE RETURN OF MAINS POWER.
- Cx - CONTACTOR x.
- CRx - CONTROL RELAY x.
- Rx - RELAY x.

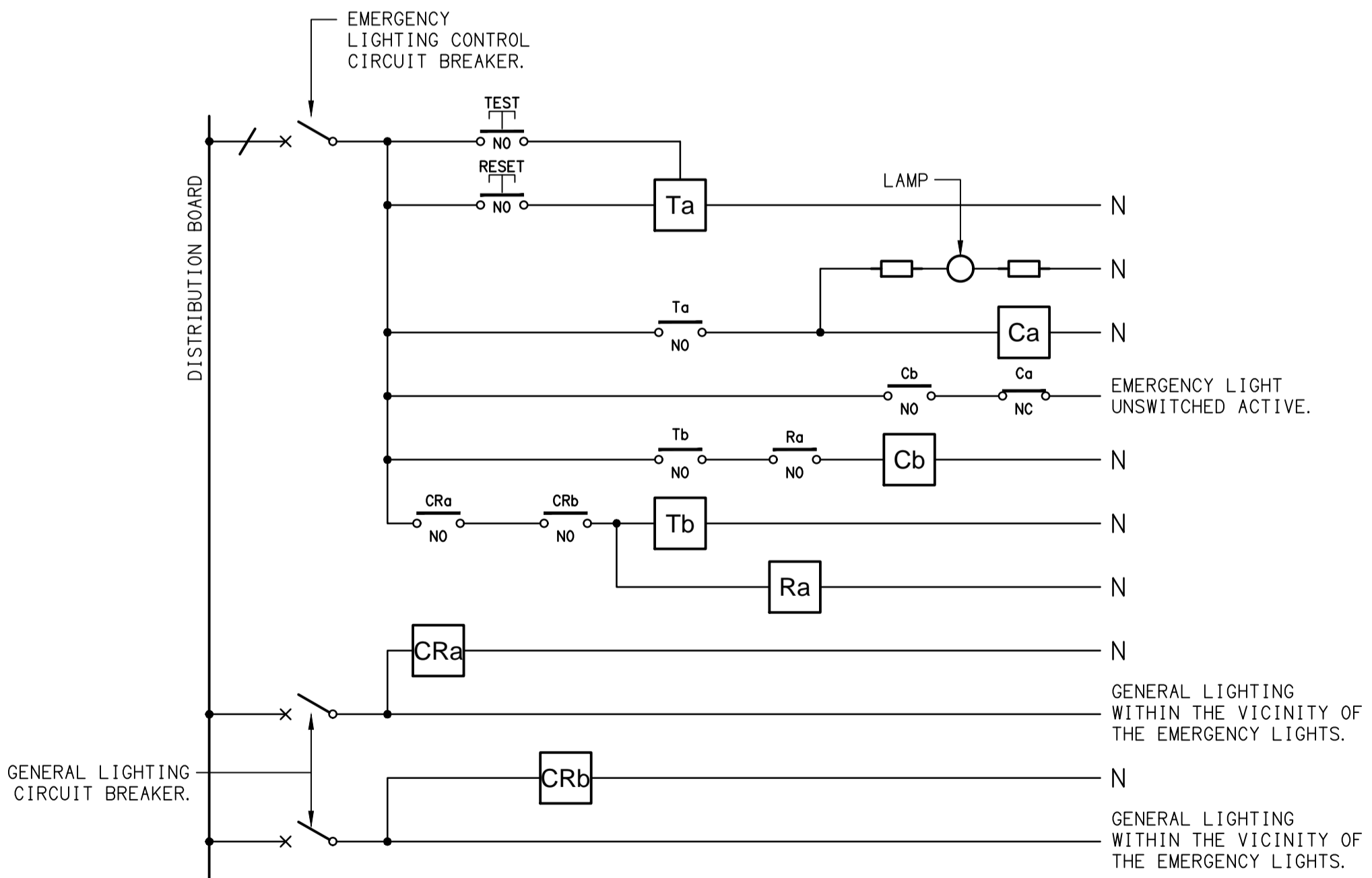

**SCHEMATIC**  
EMERGENCY LIGHTING  
NOT TO SCALE

**NOTES**

1. THE EMERGENCY LIGHT UNSWITCHED ACTIVE / GENERAL LIGHTING SWITCHED ACTIVE CIRCUIT ARRANGEMENT AND CONTROL IS TYPICAL FOR ALL CIRCUITS SUPPLYING EMERGENCY LIGHTS.
2. PROVIDE ADDITIONAL CONTROL RELAYS (CRx) CONFIGURED AS PER CRa AND CRb FOR ALL ADDITIONAL LIGHTING CIRCUITS THAT SUPPLY LIGHTS IN THE VICINITY OF THE EMERGENCY LIGHTS.

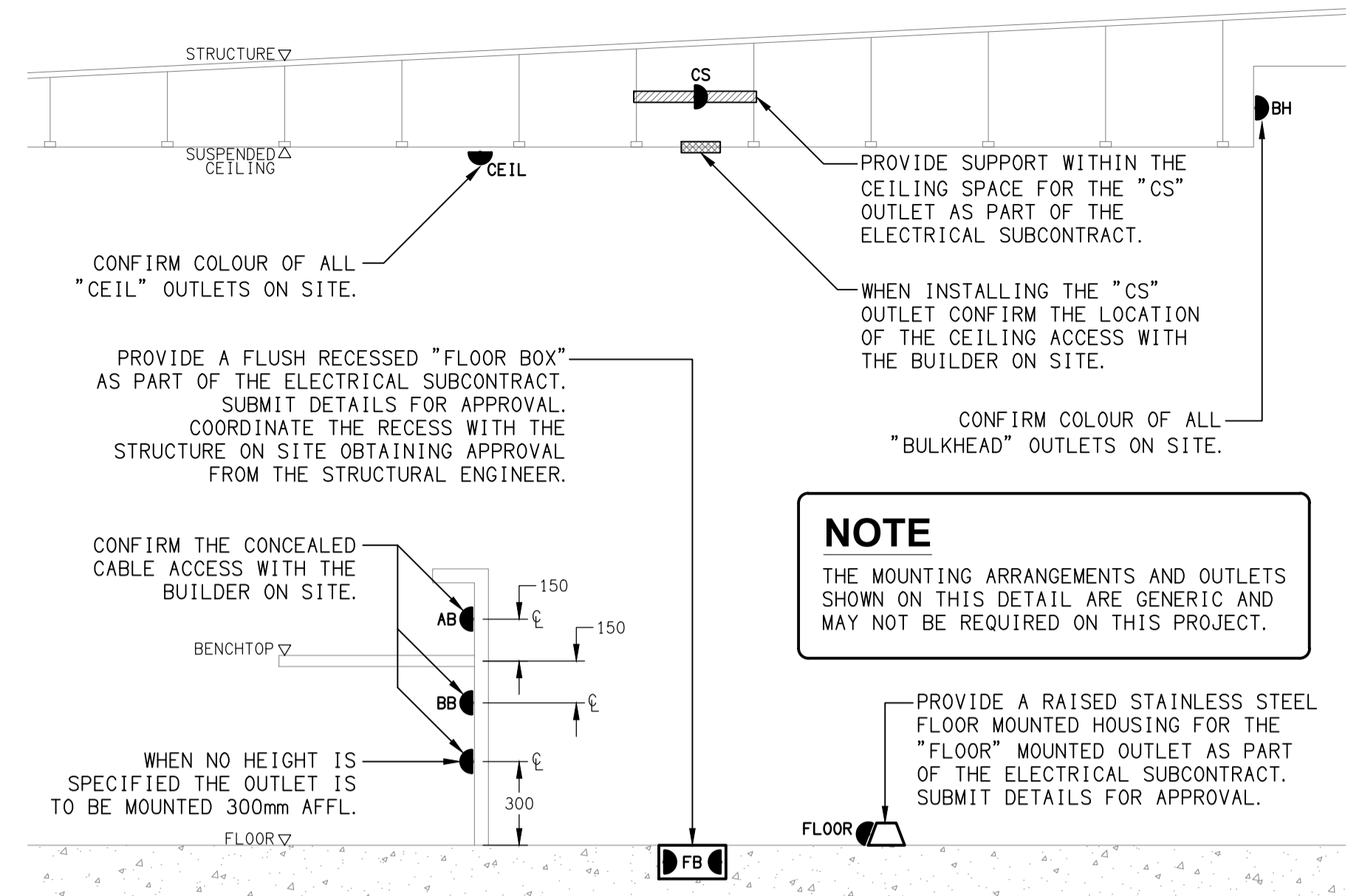

**DETAIL**  
TYPICAL OUTLET MOUNTINGS  
NOT TO SCALE

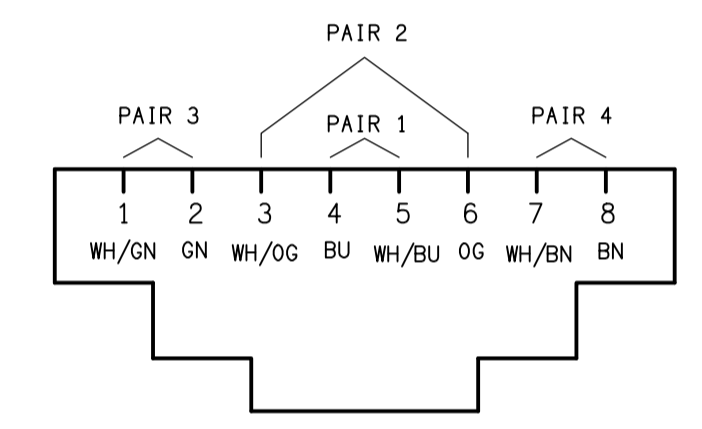

**SCHEMATIC**  
RJ45 PINOUT CONFIGURATION  
NOT TO SCALE

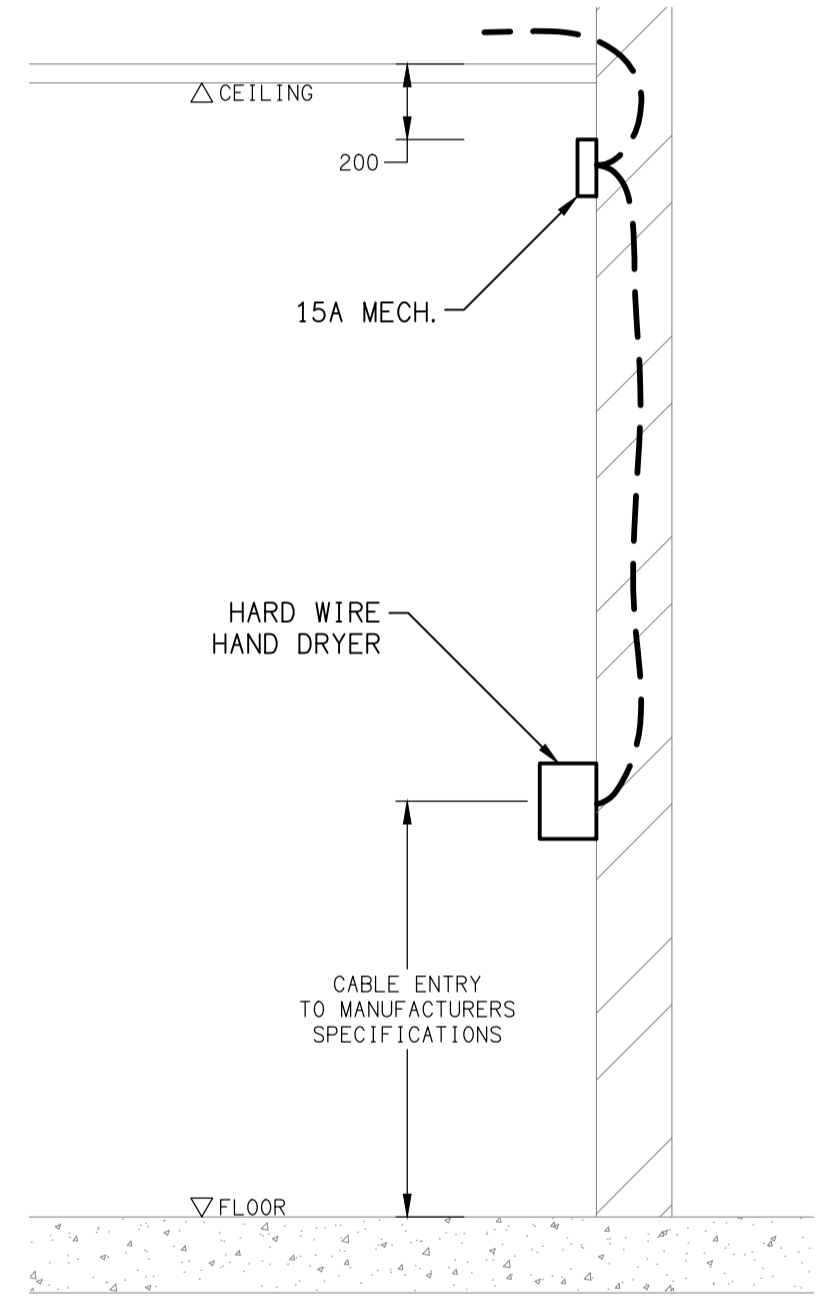

**DETAIL**  
HAND DRYER CONNECTION  
NOT TO SCALE